



MULAGO

CREAMHILL SCHOOLS – MULAGO

BABY CLASS **Holiday package**

Name: _____

I can colour my family.

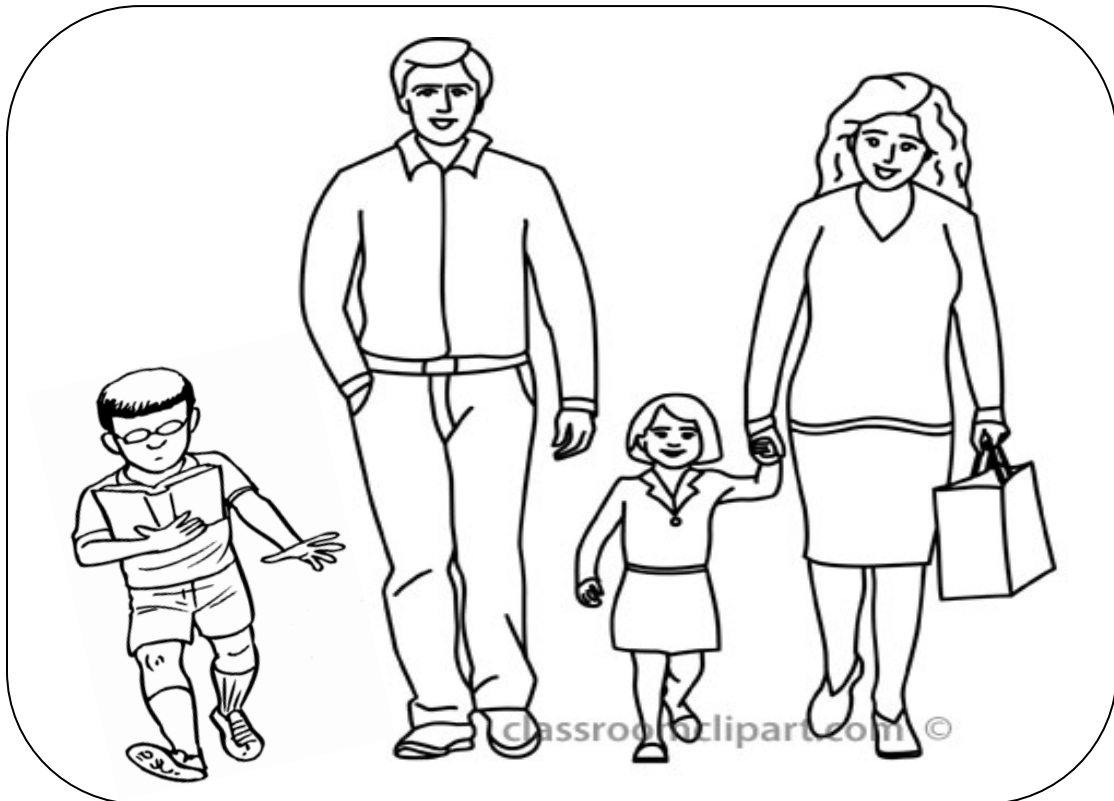

Colour things in the sitting room

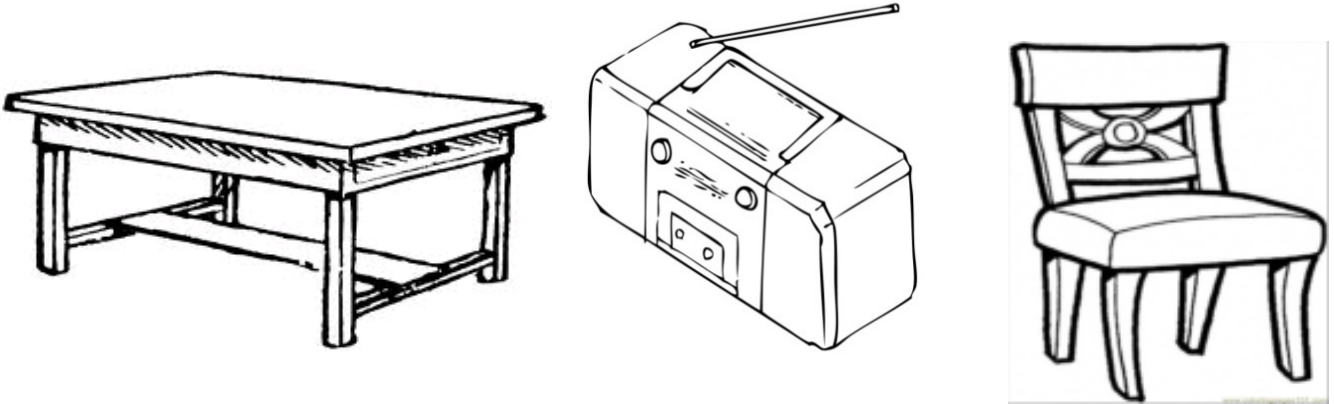

I can trace things in the bathroom.

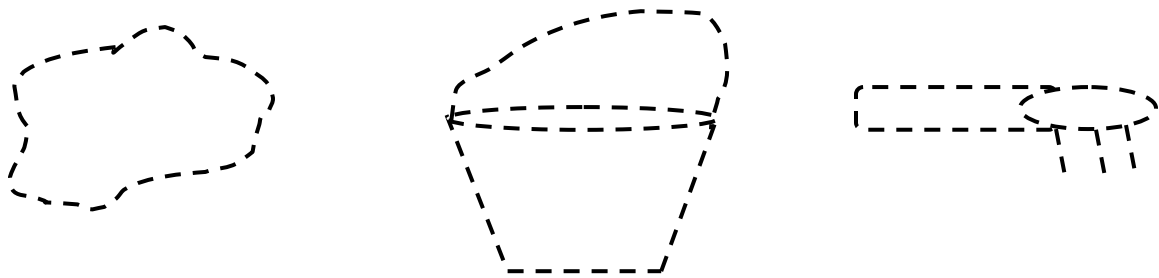

Colour things in the kitchen.

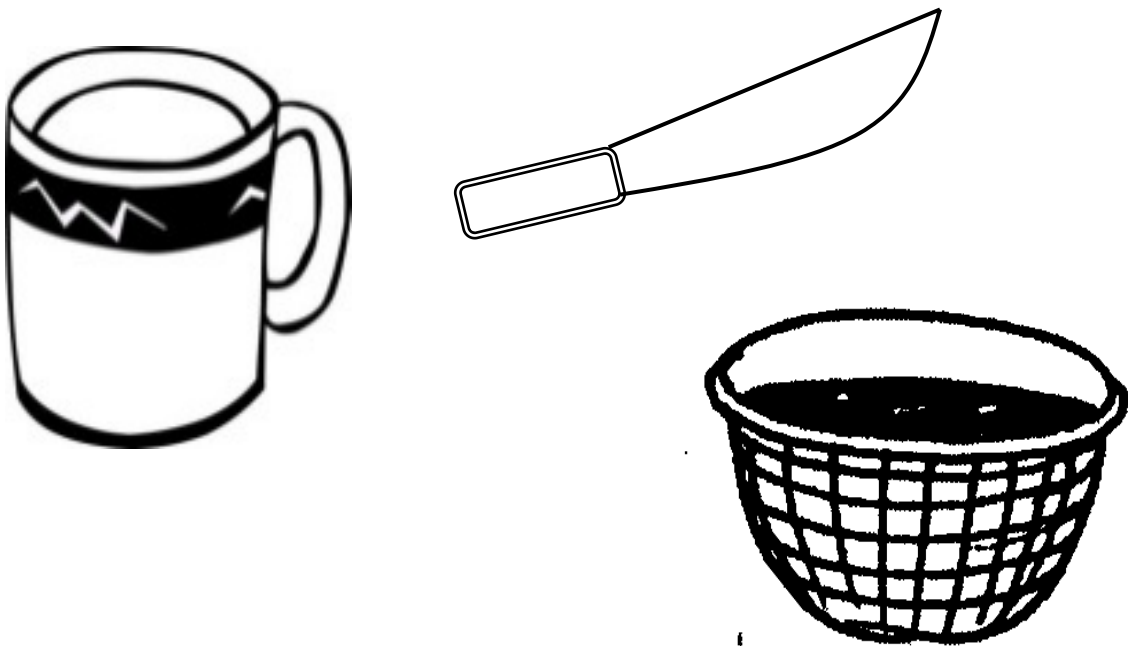

Colour a flat house.

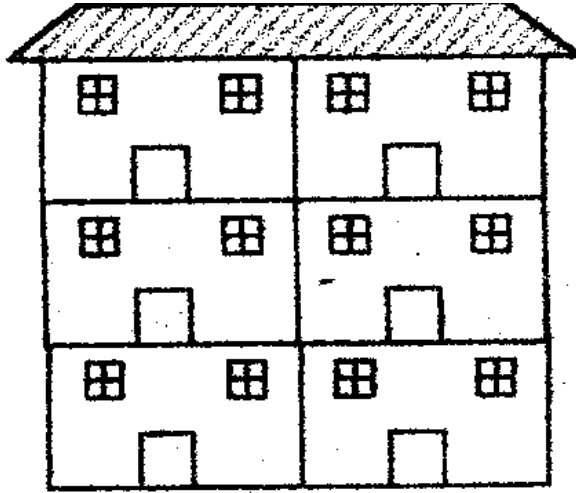

Match things found at school.

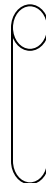
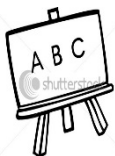
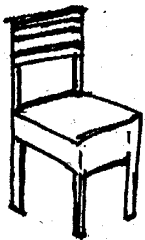

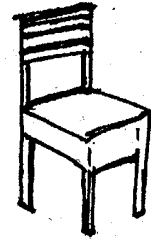

I can colour our numbers.

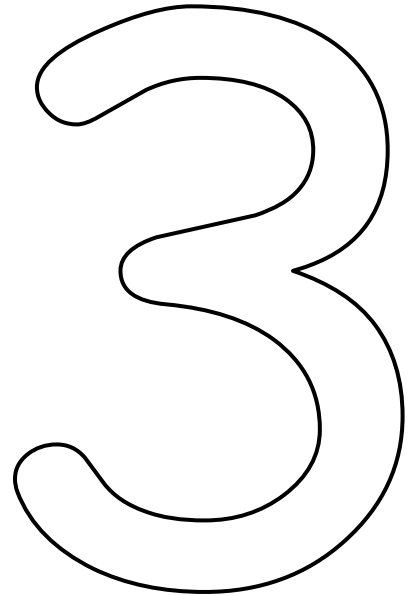
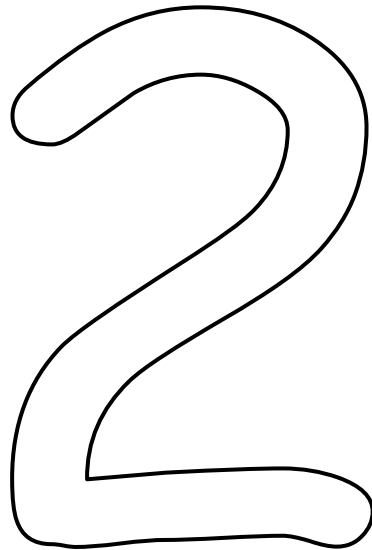
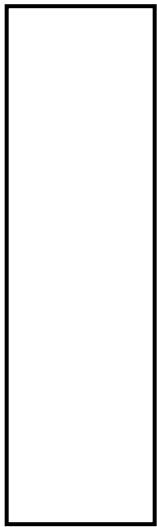

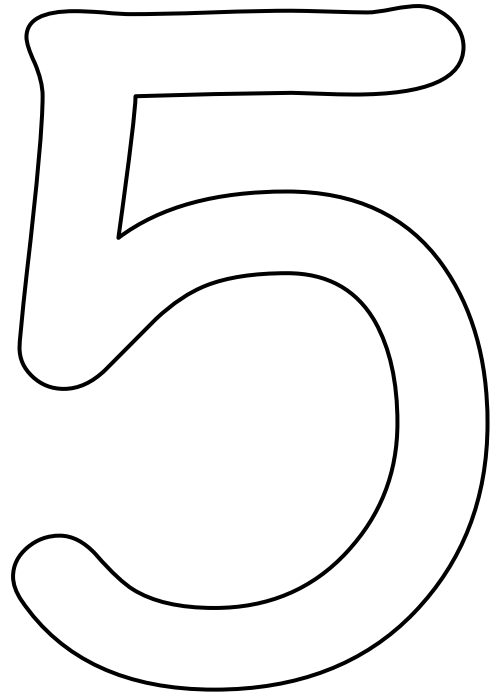
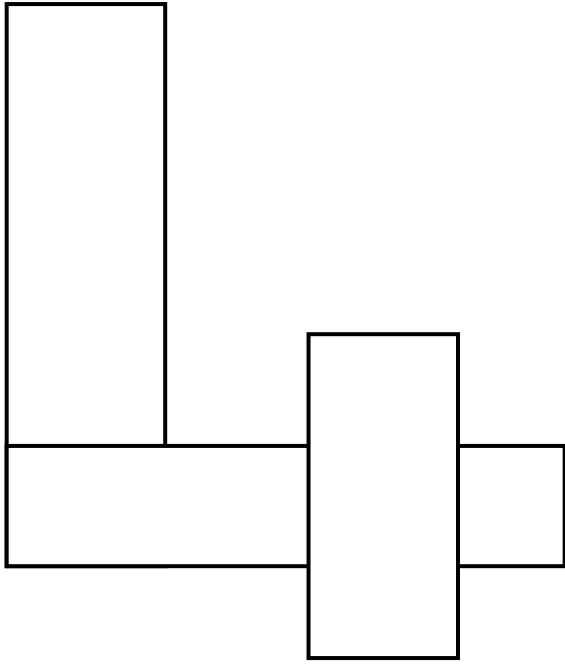

Trace these numbers.

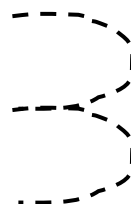
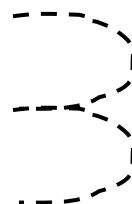
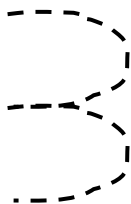
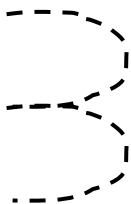
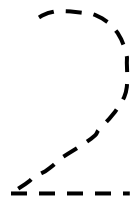
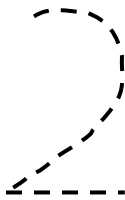
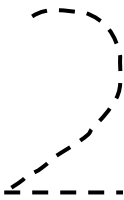

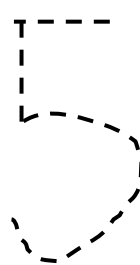
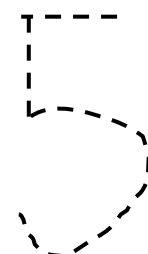
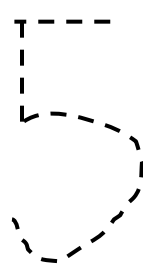
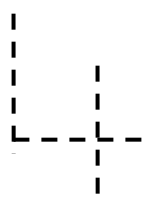
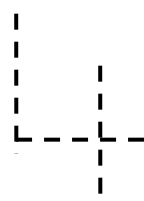
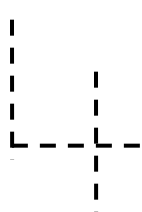
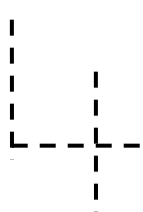

Copy and write.

1	1	1	1

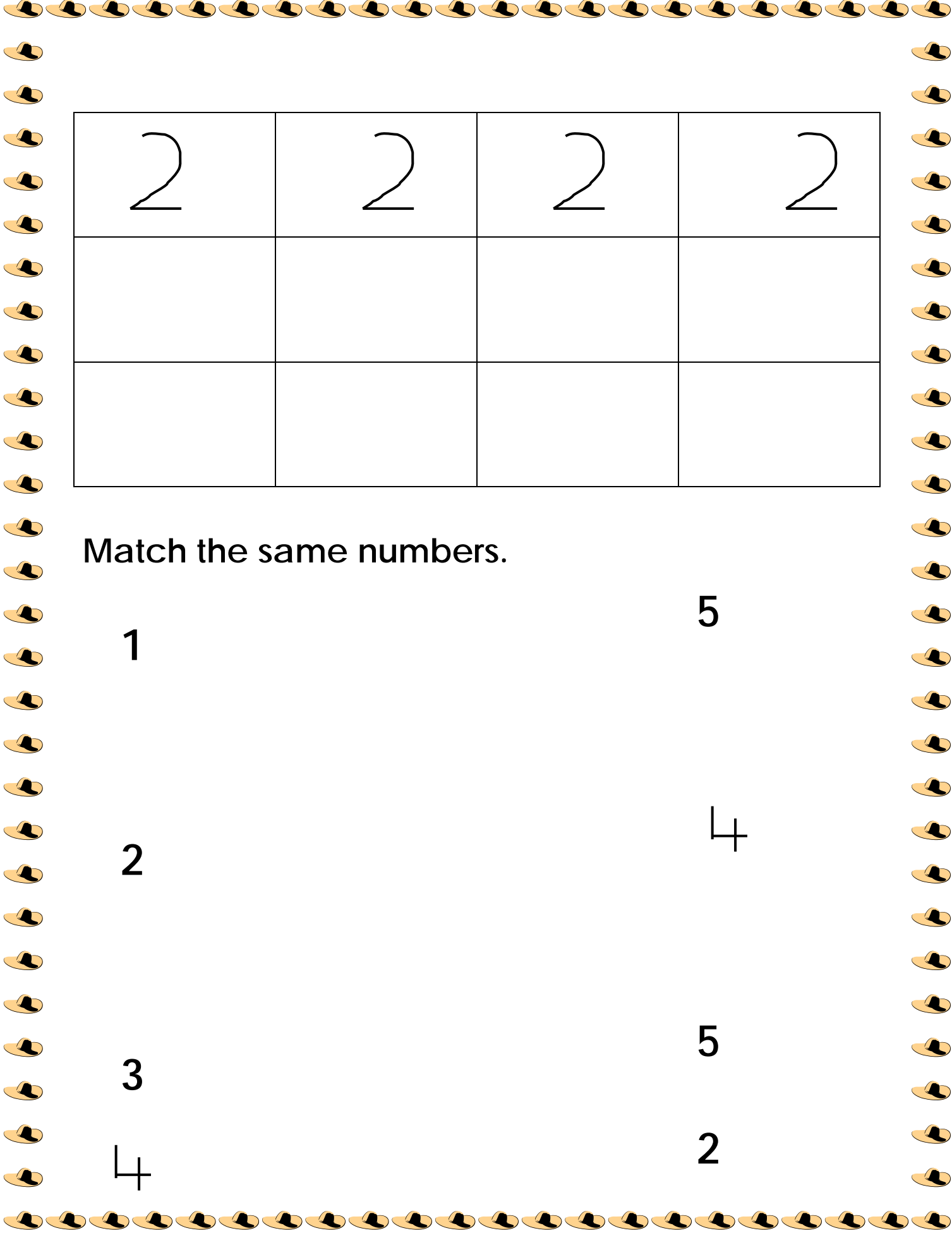

2	2	2	2

Match the same numbers.

1

5

2

4

3

5

4

2

Trace the writing symbols.

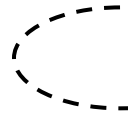
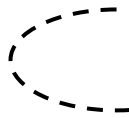
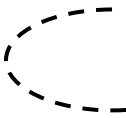
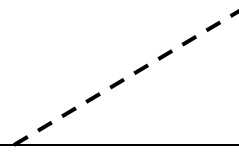
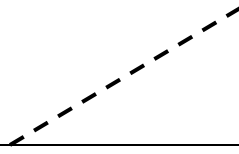
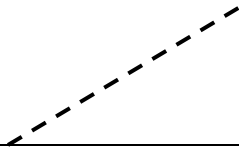

Copy and write.

Blank handwriting line with a vertical starting line on the left.

Blank handwriting line with a vertical starting line on the left.

Colour and sound

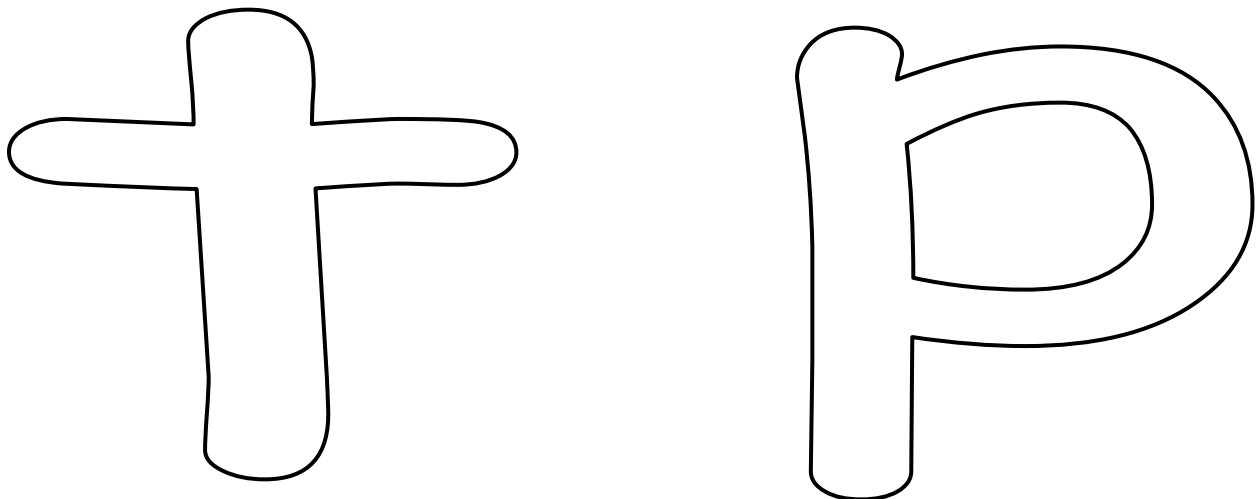
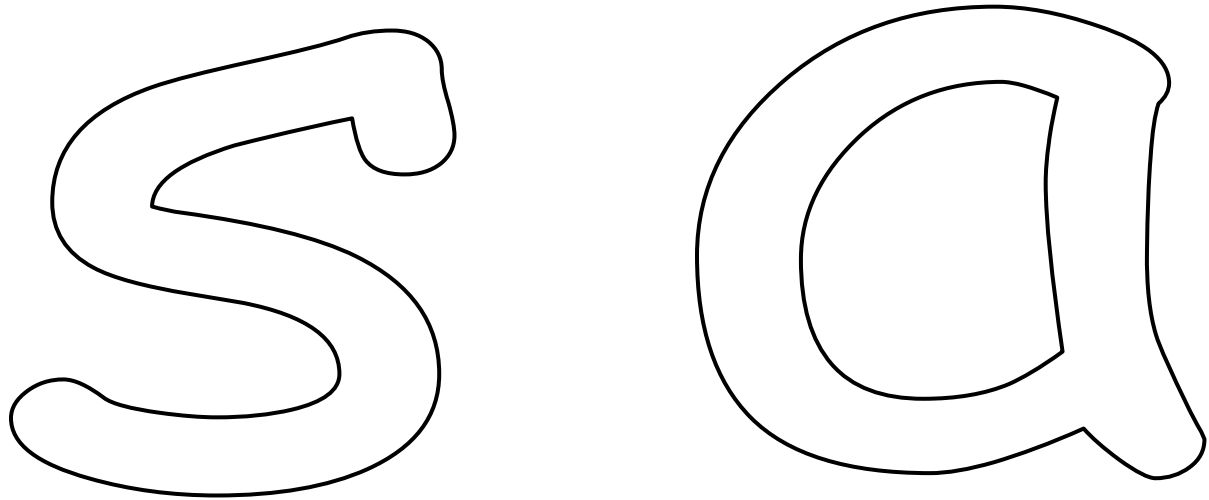

Trace .

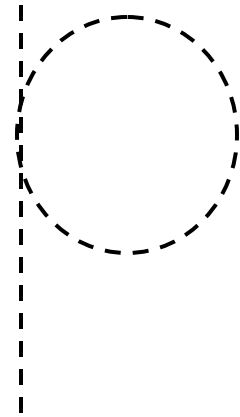
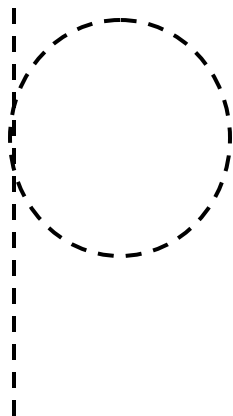
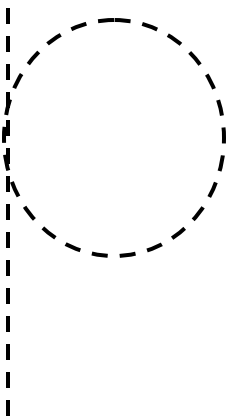
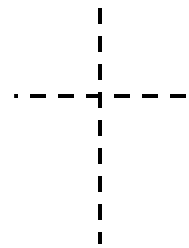
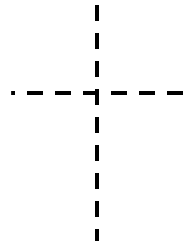
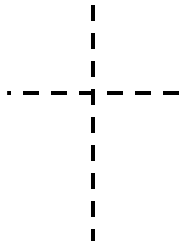
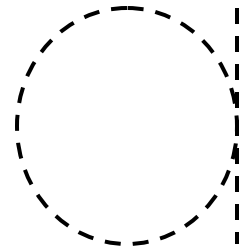
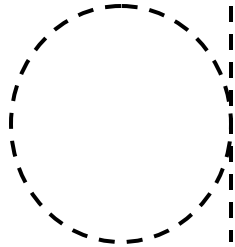
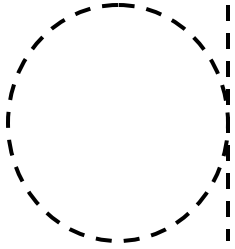
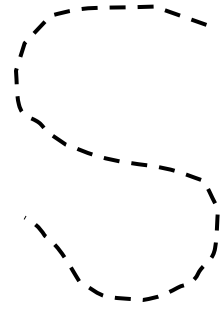
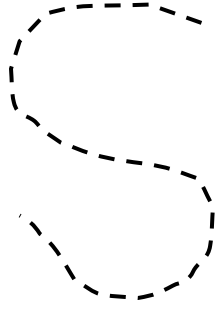
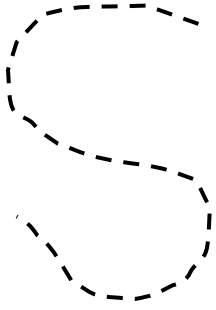

Colour animals at home.

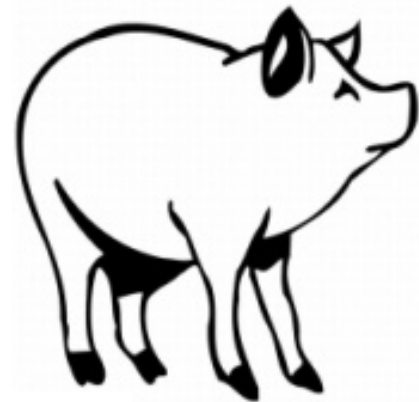
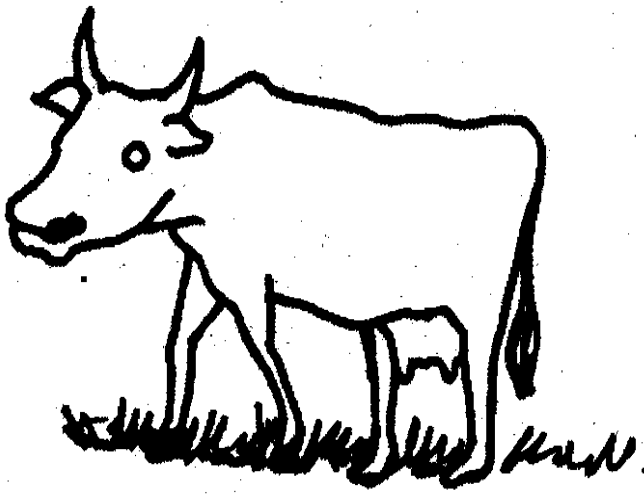
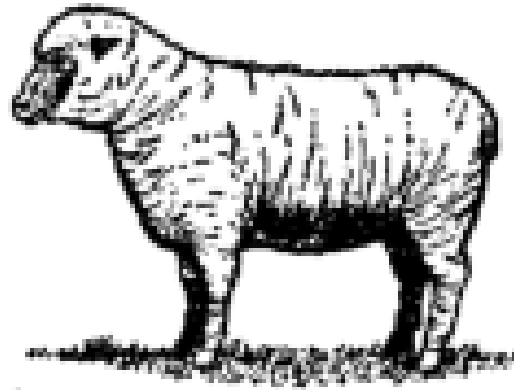
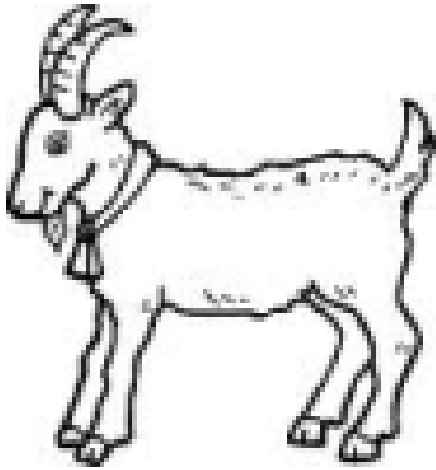

Colour birds at home.

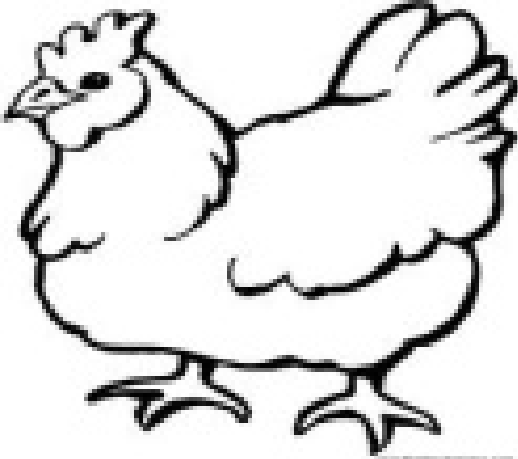
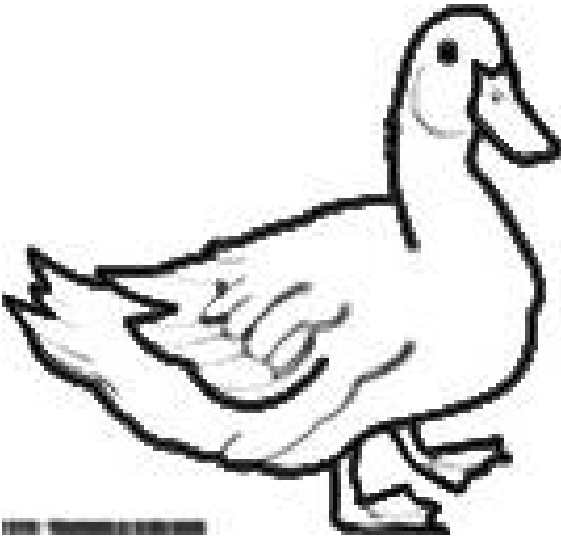
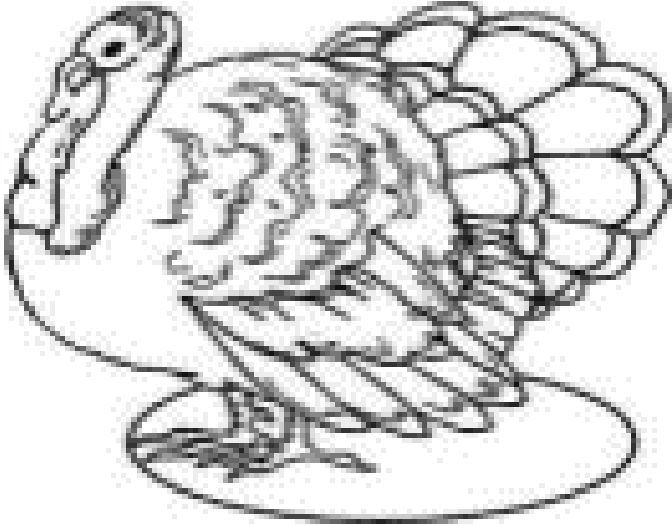
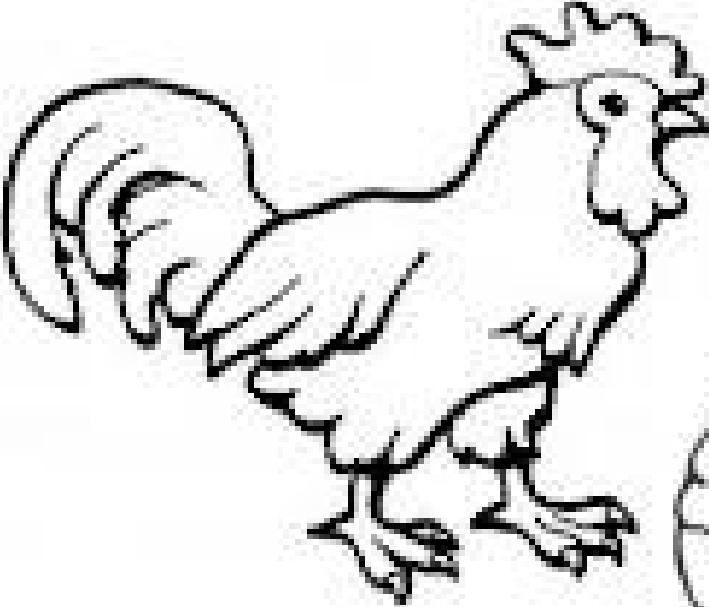

Colour important places.

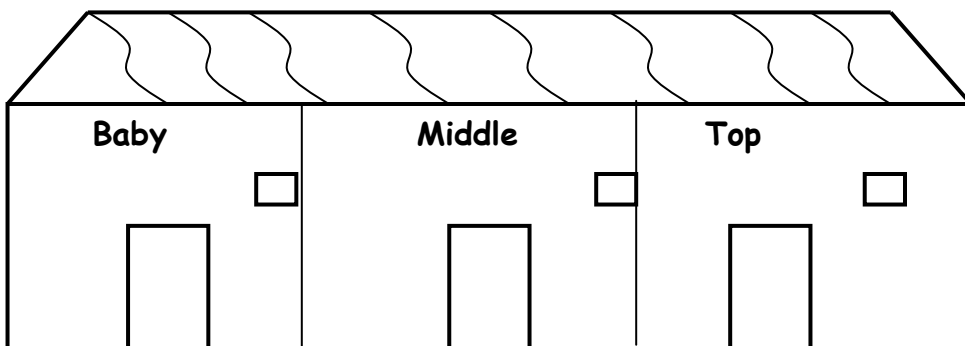
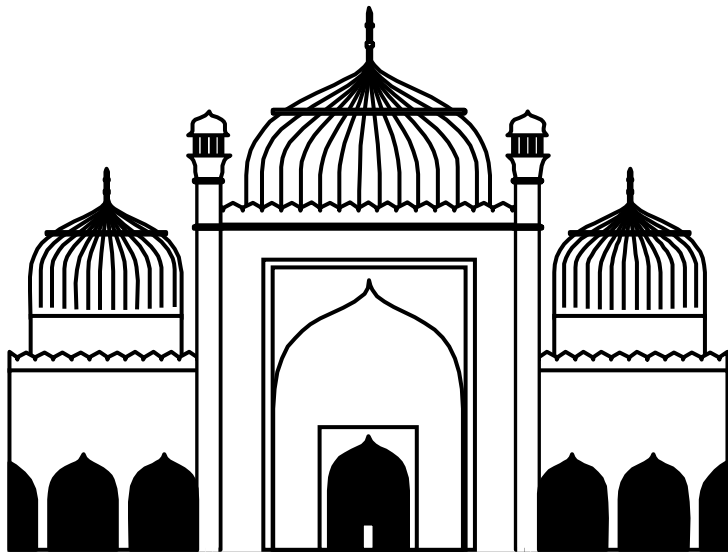

I can colour my body parts.

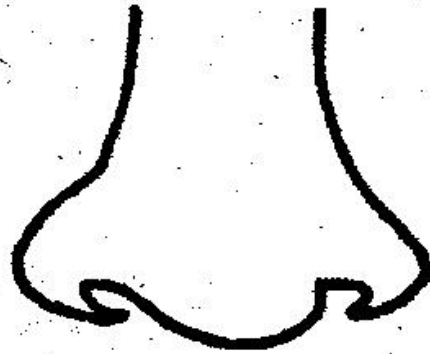
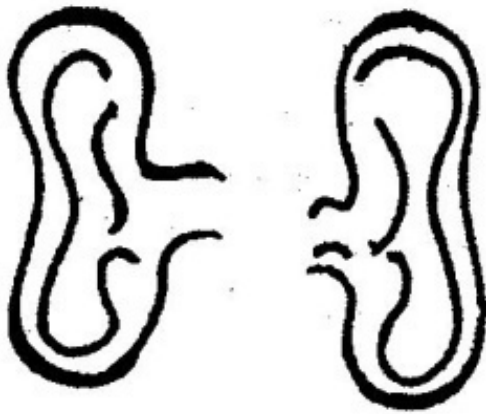
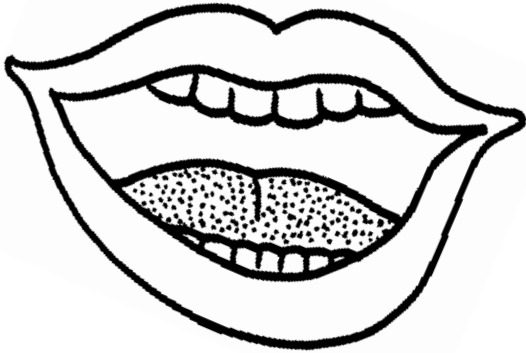

Colour our clothes.

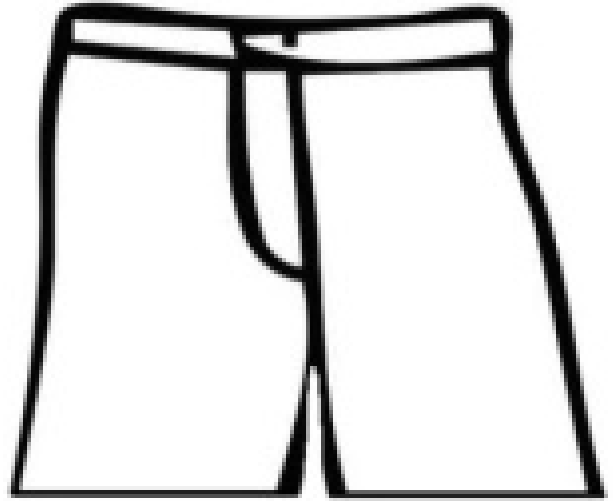

Match the same dangerous things.

