



MULAGO

CREAMHILL SCHOOLS – MULAGO

P.1

READING

SECTION A

Match words to their sounds

- | | |
|--------|---|
| snake | p |
| 1. at | n |
| 2. bat | s |
| 3. net | a |
| 4. pan | b |

Tick capital letters

a B c D E f g H i J

Name the pictures

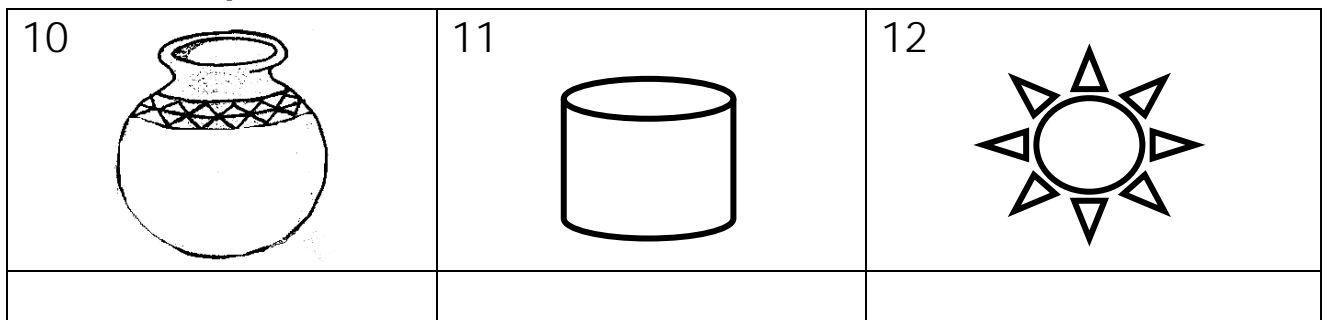

Join the sounds

13. t-a-p- _____

14. n-e-t- _____

15. p-a-n- _____

16. ti-n- _____

Circle pictures for the given sounds.

17. b   
18. f   
19. ck   
20. s   
21. d   

Write words for the given sounds.

a- axe

22. e - _____

23. c- _____

24. b- _____

Draw people found at home.

25. father	26. baby	27. mother

Tick the correct word

28.  bunk book back

29.  flower flawar flowre

30.  dasture duster dsturer

Circle a picture for the given sound



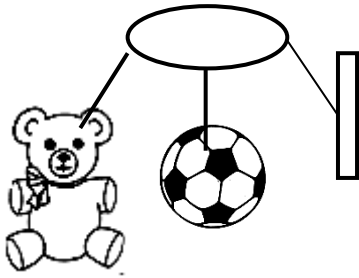

31. d

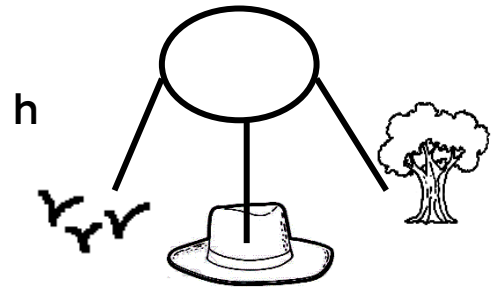

32.



Fill in the missing sound.

33 	34 	35 	36 

Read and draw

37. A man has a fan	38. A cat has a rat



39. Daddy has a hat.

Form good words and read

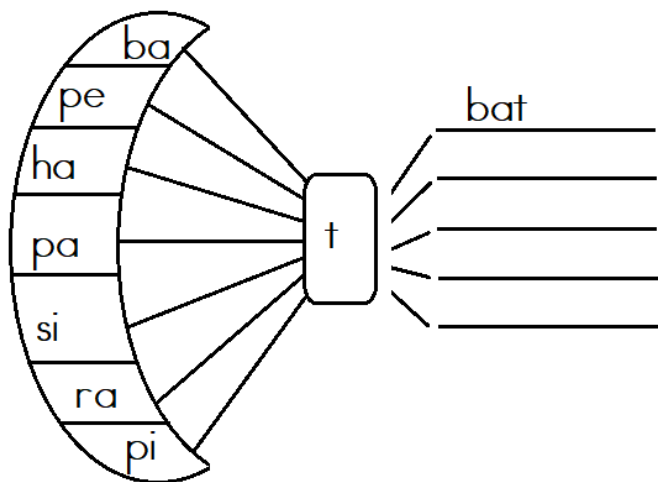

SECTION B (2marks each)

44. Copy and write neatly.

Aa

Aa

Aa

Aa

Bb

Bb

Bb

Bb

Dd

Dd

Dd

Dd

Cc

Cc

Cc

Cc