



MULAGO

# CREAMHILL SCHOOLS - MULAGO

## TOP CLASS

Name: \_\_\_\_\_

Fill in the missing sound.

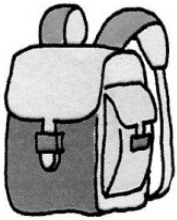

b	a	g
	a	g



d	o	g
	o	g



p	e	n
p		n



h	a	t
h	a	

Colour only umbrellas of sound u.

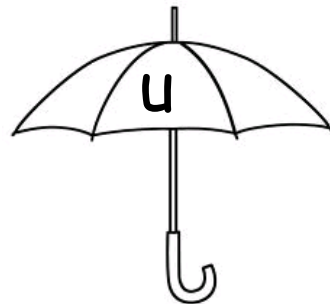
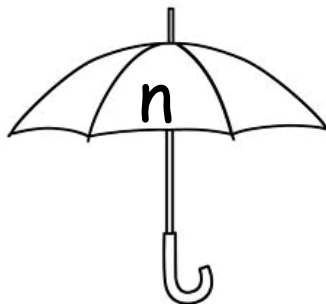
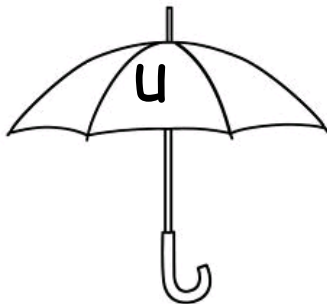

Write these numbers correctly.

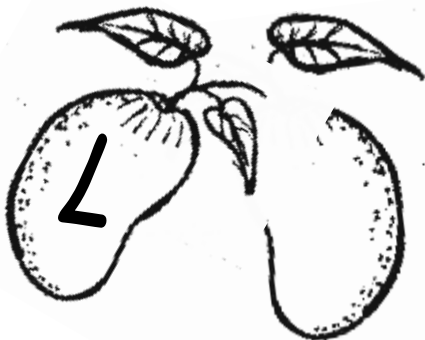
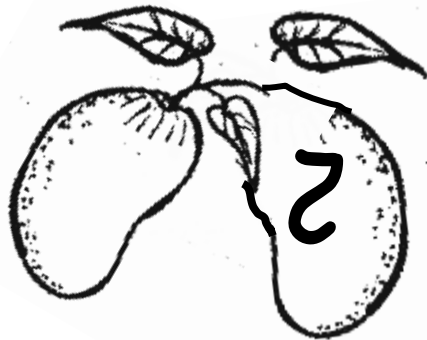
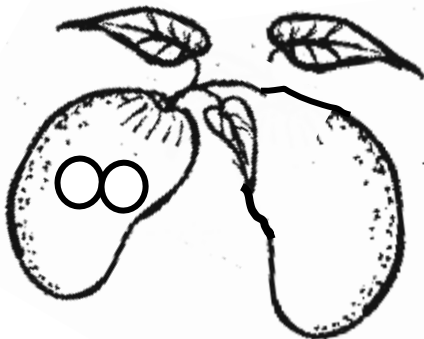
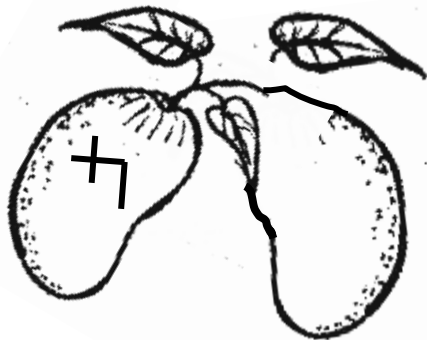
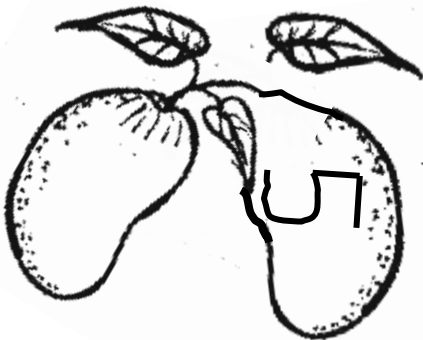
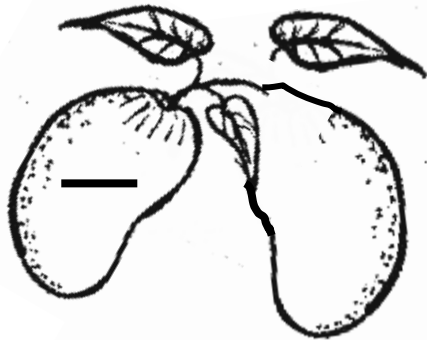
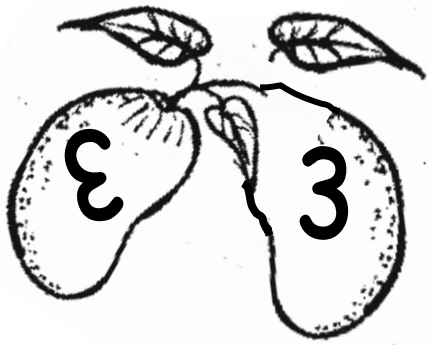



Match shapes to objects.

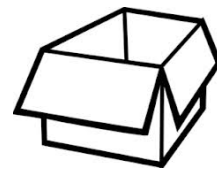
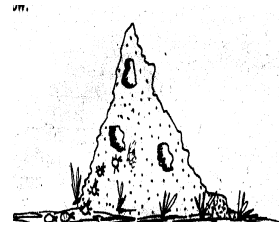
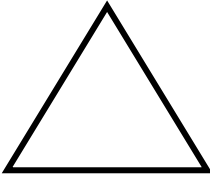
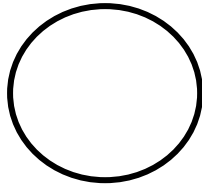

I can colour for sound e.

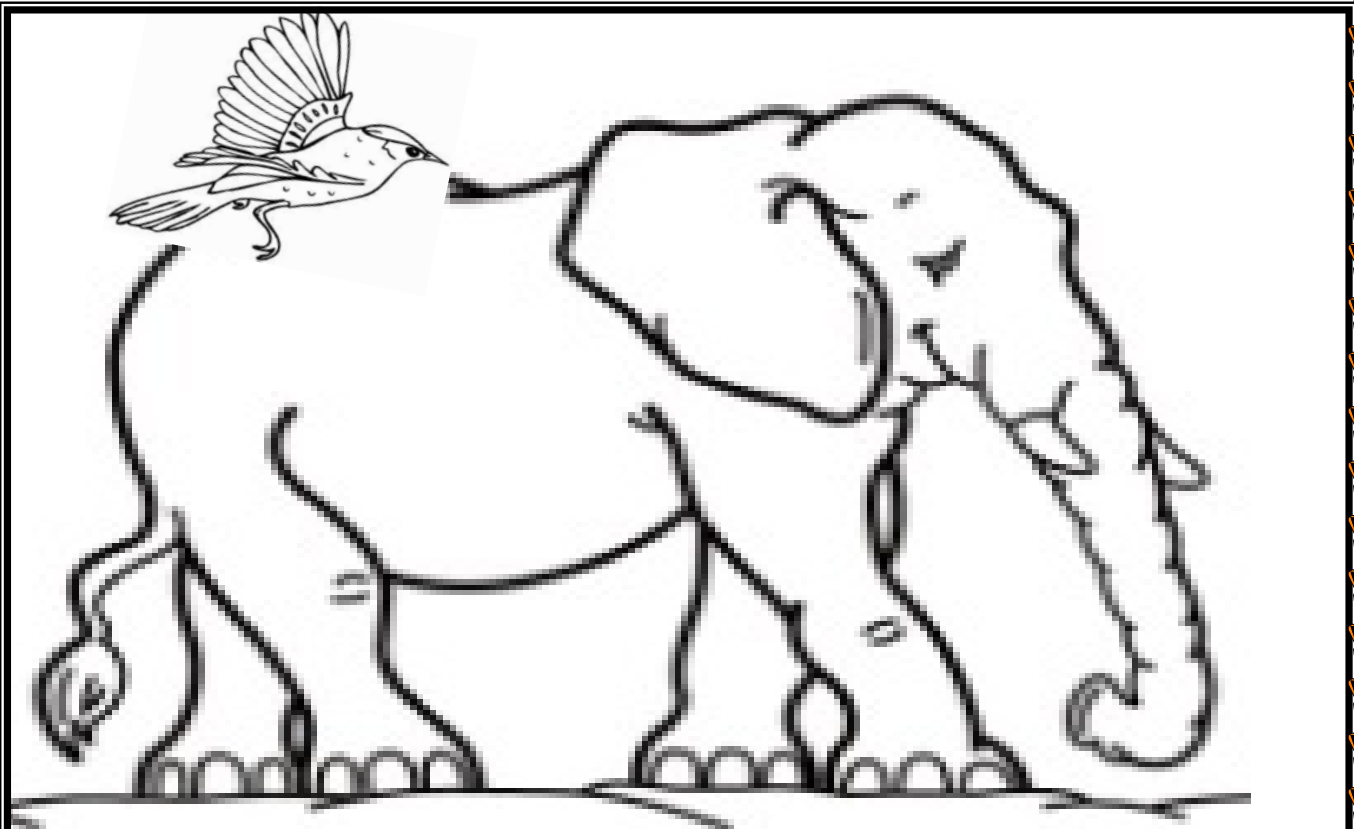

Match the same words.

hen

nut

ink

hen

tap

cop

nut

ink

cop

tap

Sound with actions and copy.

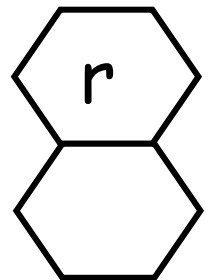
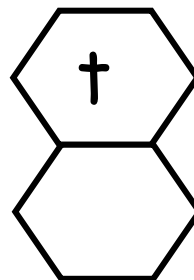
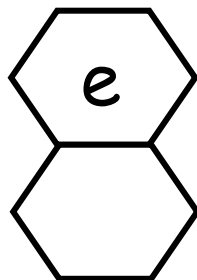
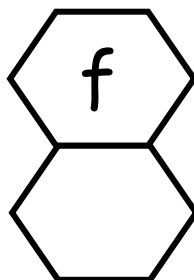
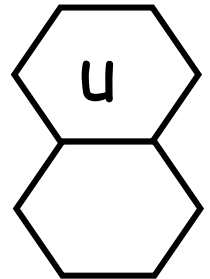
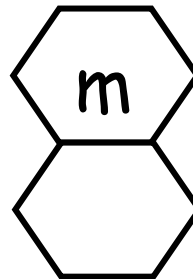
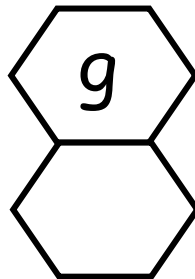
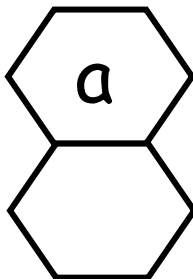
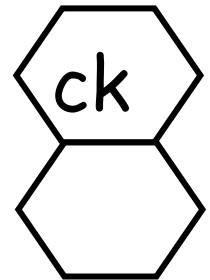
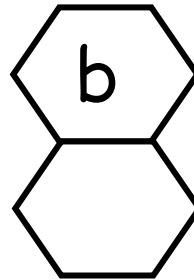
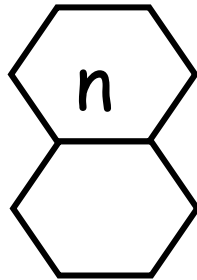
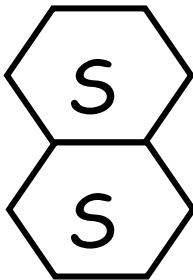

Tell and tick animals we keep at home.

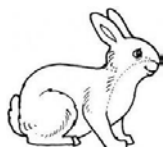
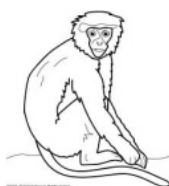
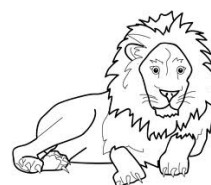
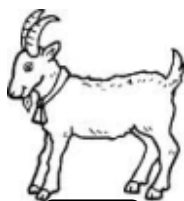
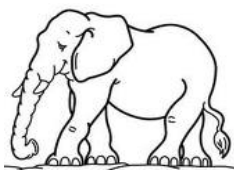
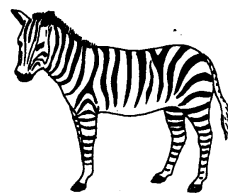
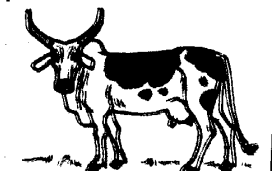

Draw these parts of the body.

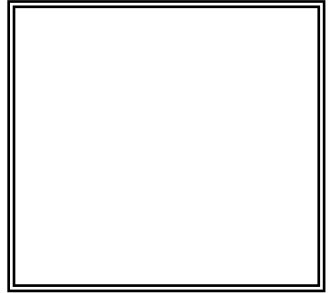
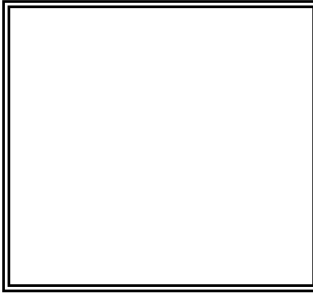
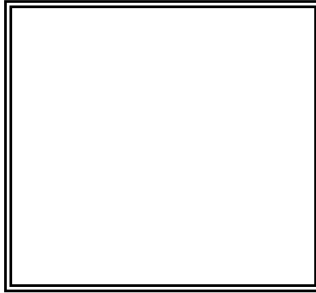
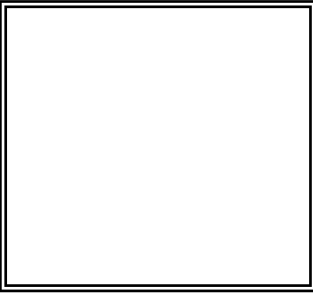
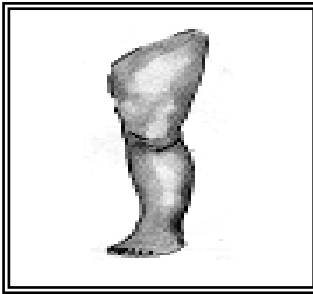
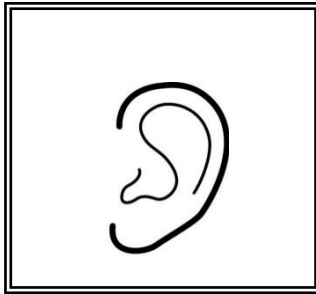
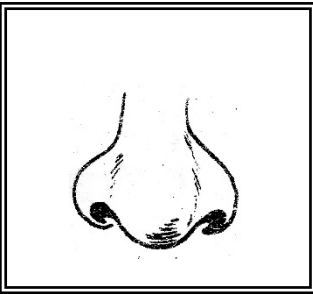

Count and circle

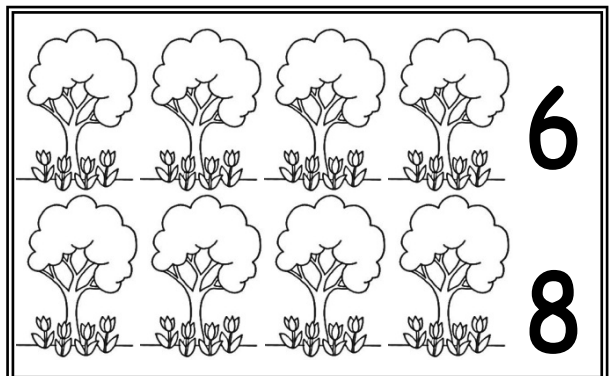
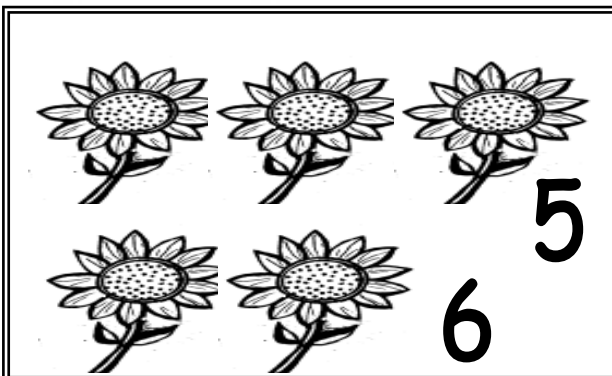
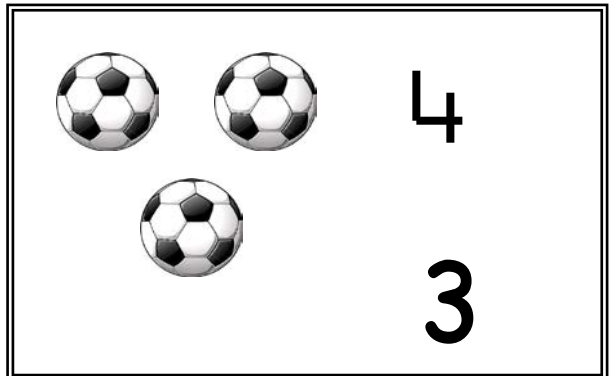
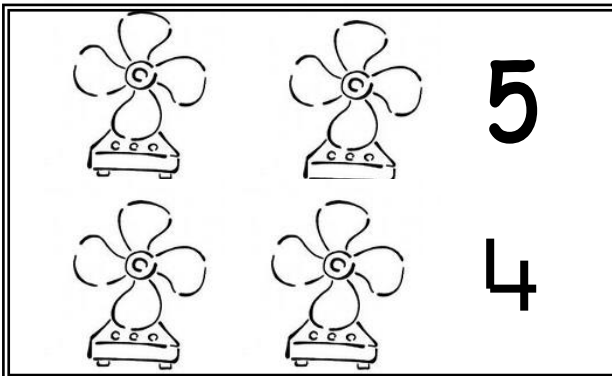
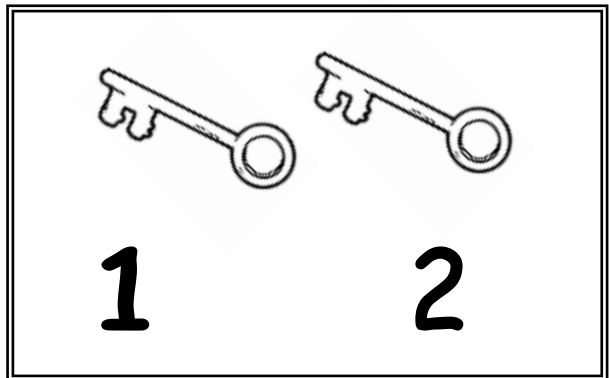
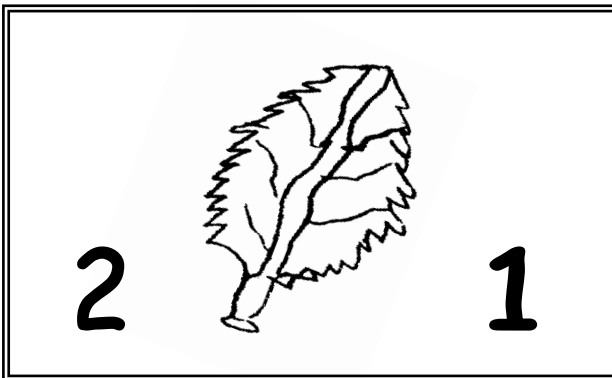

Tell and match.

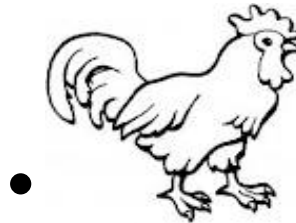
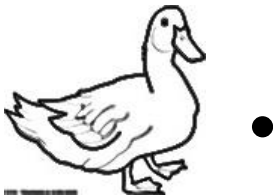
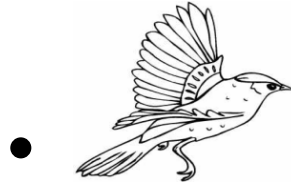
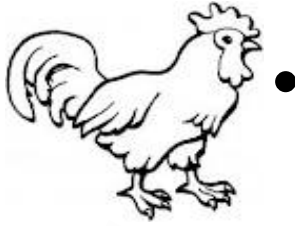

Tell and colour this dangerous insect.

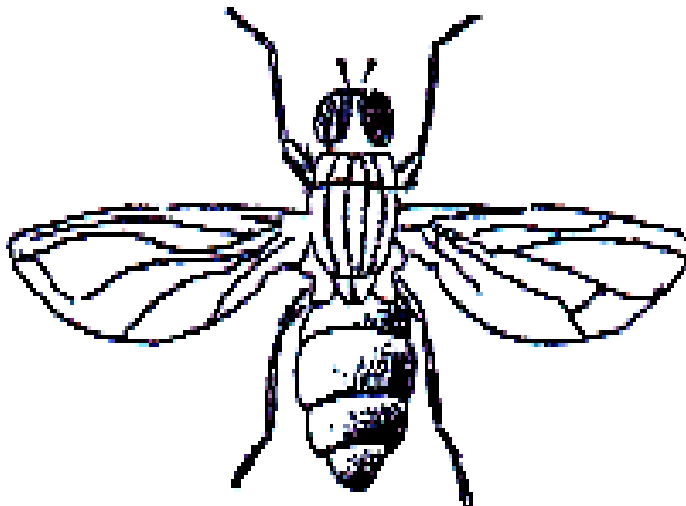

Ring only things we use at home.

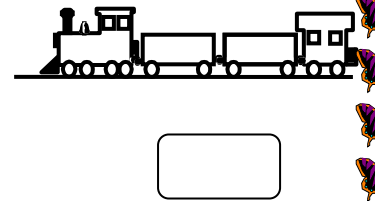
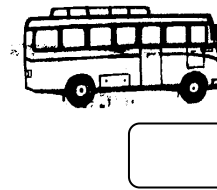
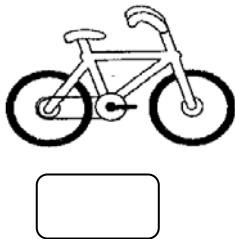
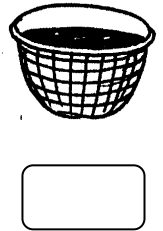
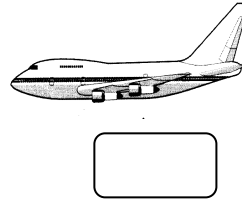
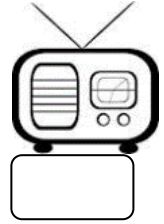
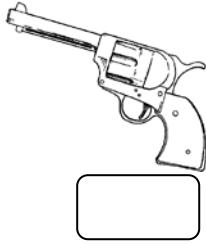

Tell and match the same.

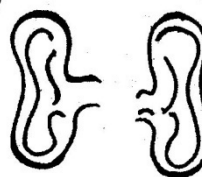
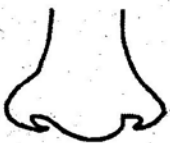
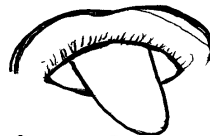
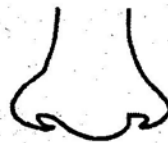
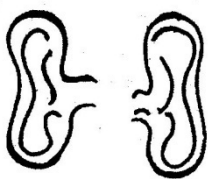

Colour the ways we pray.



Match big to small.

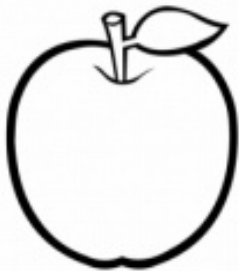
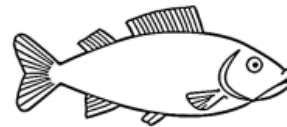
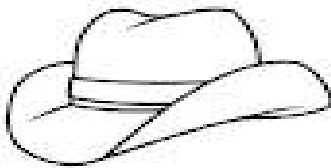
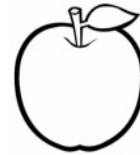
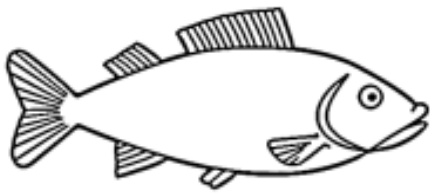

Draw the missing parts on each head.

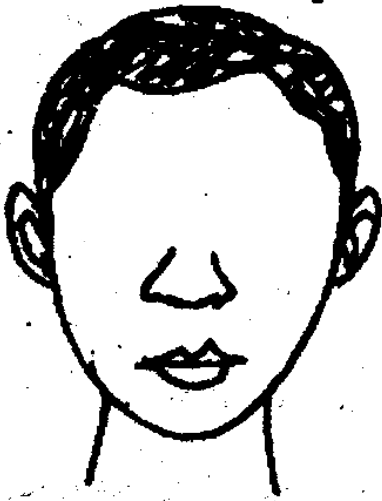
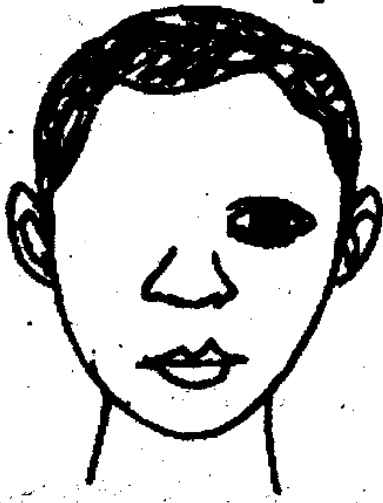

Match sounds to words.

- |   |     |
|---|-----|
| t | gap |
| g | log |
| p | tap |
| r | mat |
| m | pen |
| l | rat |

Write any 6 sound you know.

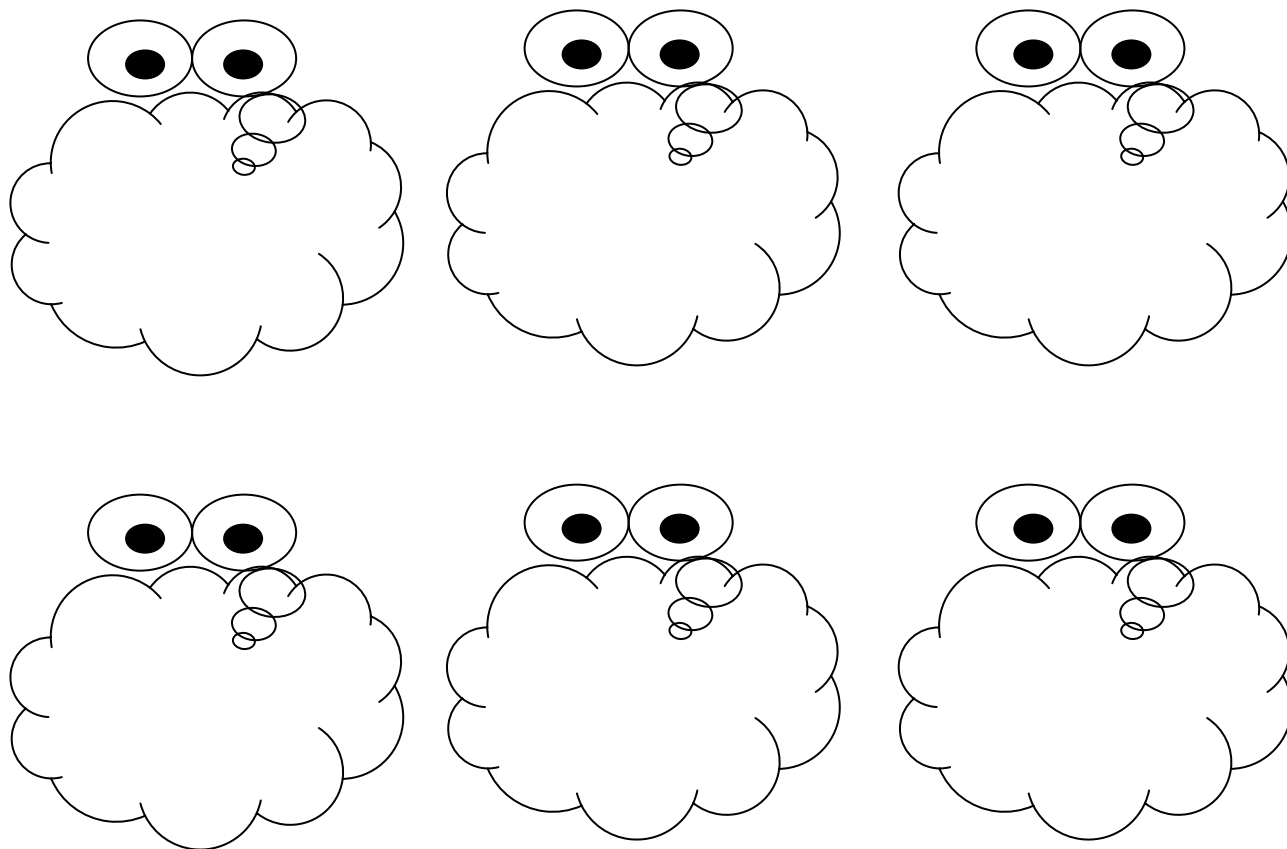

Tell and colour friends of sound g

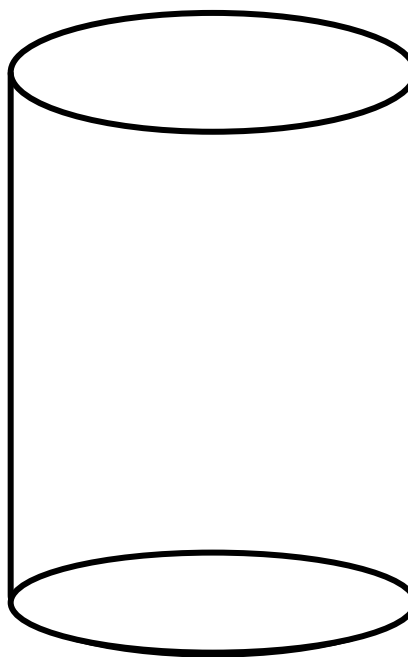
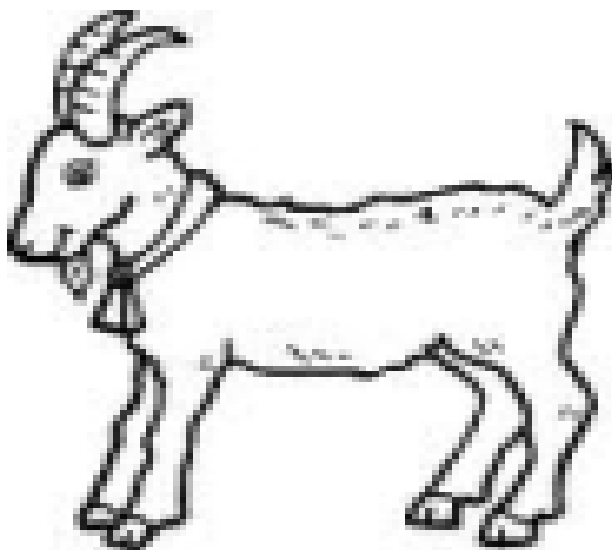

I can colour a rainy weather.



I can colour Mummy breast feeding

